

TPS61183 White-LED Driver With PWM Interface and Programmable PWM Dimming

1 Features

- 4.5-V to 24-V Input Voltage
- 38-V Maximum Output Voltage
- Integrated 2-A, 40-V MOSFET
- 280-kHz to 1-MHz Programmable Switching Frequency
- Adaptive Boost Output to WLED Voltages
- Wide PWM Dimming Frequency Range
 - 100 Hz to 50 KHz for Direct PWM Mode
 - 100 Hz to 22 KHz for Frequency Programmable Mode
- 100:1 Dimming Ratio at 20 kHz
- 10000:1 Dimming Ratio at 200 Hz (Direct PWM mode)
- Small External Components
- Integrated Loop Compensation
- Six Current Sinks of 30 mA, Maximum
- 1.5% (Typical) Current Matching
- PWM Brightness Interface Control
- PWM Programmable Mode Brightness Dimming Method or Direct PWM Dimming Method
- 4000-V HBM ESD Protection
- Programmable Overvoltage Threshold
- Built-in WLED Open and Short Protections
- Thermal Shutdown

2 Applications

- Notebooks
- Tablets
- Monitors
- Industrial PCs
- Human Machine Interface Screens
- ATMs
- Fishfinder

3 Description

The TPS61183 device provides a highly integrated white-LED (WLED) driver solution for notebook LCD backlights. This device has a built-in high-efficiency boost regulator with integrated 2-A, 40-V power MOSFET. The six current sink regulators provide high-precision current regulation and matching. The device can support a total of up to 60 WLEDs. In addition, the boost output automatically adjusts its voltage to the WLED forward voltage to optimize efficiency.

The TPS61183 supports the programmable brightness dimming method. In this configuration, the dimming duty cycle of the WLED current is controlled by the input PWM signal but the dimming frequency is fixed and set by an external resistor. During direct PWM dimming, the WLED current completely synchronized with the input PWM signal's duty cycle and frequency.

Device Information⁽¹⁾

PART NUMBER	PACKAGE	BODY SIZE (NOM)
TPS61183	QFN	4.00 mm × 4.00 mm

(1) For all available packages, see the orderable addendum at the end of the data sheet.

Typical Programmable PWM-Mode Application

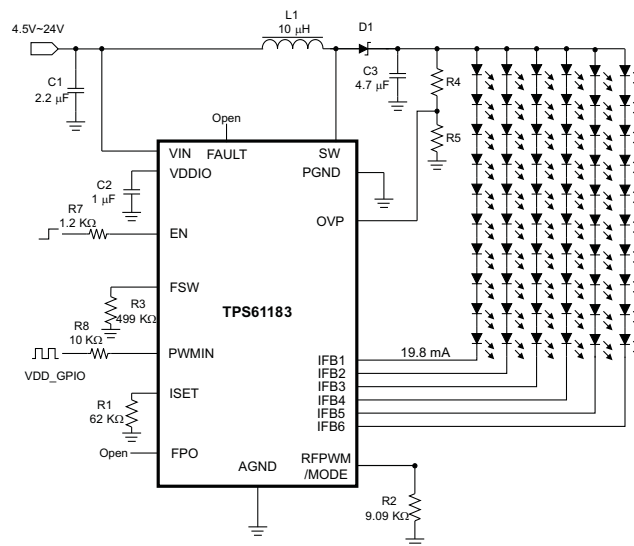

Table of Contents

1 Features	1	7.4 Device Functional Modes.....	12
2 Applications	1	8 Application and Implementation	16
3 Description	1	8.1 Application Information.....	16
4 Revision History	2	8.2 Typical Application	16
5 Pin Configuration and Functions	3	9 Power Supply Recommendations	19
6 Specifications	4	10 Layout	20
6.1 Absolute Maximum Ratings	4	10.1 Layout Guidelines	20
6.2 ESD Ratings.....	4	10.2 Layout Example	20
6.3 Recommended Operating Conditions.....	4	11 Device and Documentation Support	21
6.4 Thermal Information	5	11.1 Device Support.....	21
6.5 Electrical Characteristics.....	5	11.2 Receiving Notification of Documentation Updates	21
6.6 Typical Characteristics	7	11.3 Community Resources.....	21
7 Detailed Description	10	11.4 Trademarks	21
7.1 Overview	10	11.5 Electrostatic Discharge Caution.....	21
7.2 Functional Block Diagram	10	11.6 Glossary	21
7.3 Feature Description.....	11	12 Mechanical, Packaging, and Orderable Information	21

4 Revision History

NOTE: Page numbers for previous revisions may differ from page numbers in the current version.

Changes from Revision C (October 2016) to Revision D Page

• Changed TPS61183 Layout drawing	20
---	-----------

Changes from Revision B (February 2012) to Revision C Page

• Deleted "For Notebooks" from title	1
• Changed "300 kHz" to "280 kHz" in <i>Features</i>	1
• Added new "Applications"	1
• Added <i>Device Information</i> and <i>Pin Configuration and Functions</i> sections, <i>ESD Ratings</i> and <i>Thermal Information</i> tables, <i>Feature Description</i> , <i>Device Functional Modes</i> , <i>Application and Implementation</i> , <i>Power Supply Recommendations</i> , <i>Layout</i> , <i>Device and Documentation Support</i> , and <i>Mechanical, Packaging, and Orderable Information</i> sections; remove <i>Ordering Information</i> - see POA.....	1
• Changed "300 kHz" to "280 kHz" in <i>Pin Functions</i>	3
• Changed "300 kHz" to "280 kHz" in <i>ROC</i> table - 2 places.....	4
• Changed "300 kHz" to "280 kHz"	11

Changes from Revision A (July 2010) to Revision B Page

• Changed Figure 18 X axis unit from mA to A.....	19
• Changed Figure 19 X axis unit from mA to A.....	19

Changes from Original (June 2010) to Revision A Page

• Changed Typical Application graphic	1
• Changed value of ceramic capacitor from 0.1 to 1 μ F	3
• Changed value of bypass capacitor from 0.1 to 1 μ F	11
• Changed BRIGHTNESS DIMMING CONTROL section.....	12
• Deleted PWM BRIGHTNESS CONTROL INTERFACE section	13

5 Pin Configuration and Functions

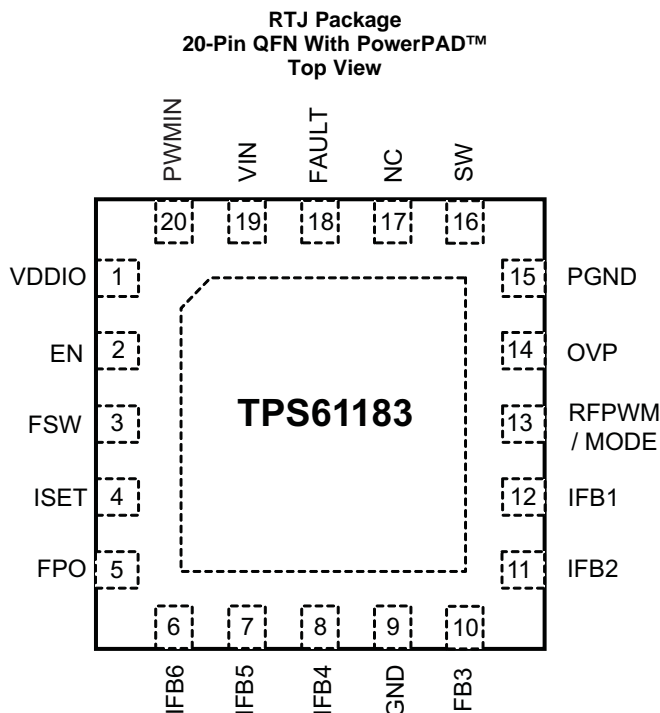

PowerPAD™ information goes here.

Pin Functions

PIN		TYPE	DESCRIPTION
NO.	NAME		
1	VDDIO	A	Internal pre_regulator — connect a 1- μ F ceramic capacitor to VDDIO
2	EN	I	Enable
3	FSW	I	Switching-frequency selection pin. Use a resistor to set the frequency between 280 kHz to 1 MHz.
4	ISET	I	Full-scale LED current set pin. Connecting a resistor to the pin programs the current level.
5	FPO	O	Fault protection output to indicate fault conditions including OVP, OC, and OT.
6, 7, 8, 10, 11, 12	IFB1 to IFB6	A	Regulated current sink input pins
9	GND	G	Analog ground
13	RFPWM / MODE	I	Dimming frequency program pin with an external resistor / mode selection
14	OVP	A	Overvoltage clamp pin / voltage feedback
15	PGND	G	Power ground
16	SW	A	Drain connection of the internal power FET
17	NC	—	No connection
18	FAULT	O	Fault pin to drive external ISO FET
19	VIN	A	Supply input pin
20	PWMIN	I	PWM signal input pin
PowerPAD™	—	—	Connect to GND plane for better thermal performance

A: Analog; G: Ground; I: Input; O: Output; P: Power

6 Specifications

6.1 Absolute Maximum Ratings

 over operating free-air temperature range (unless otherwise noted)⁽¹⁾

		MIN	MAX	UNIT
Voltage range ⁽²⁾	VIN, FAULT	–0.3	24	V
	FPO	–0.3	7	
	SW	–0.3	40	
	EN, PWM, IFB1 to IFB4	–0.3	20	
	on all other pins	–0.3	3.6	
Continuous power dissipation		See Thermal Information		
Operating junction temperature range		–40	150	°C
T _{stg}	Storage temperature	–65	150	°C

- (1) Stresses beyond those listed under *Absolute Maximum Ratings* may cause permanent damage to the device. These are stress ratings only, which do not imply functional operation of the device at these or any other conditions beyond those indicated under *Recommended Operating Conditions*. Exposure to absolute-maximum-rated conditions for extended periods may affect device reliability.
- (2) All voltage values are with respect to network ground terminal.

6.2 ESD Ratings

		VALUE	UNIT
V _(ESD) Electrostatic discharge	Human-body model (HBM), per ANSI/ESDA/JEDEC JS-001 ⁽¹⁾	±4000	V
	Charged-device model (CDM), per JEDEC specification JESD22-C101 ⁽²⁾	±1500	
	Machine model	200	

- (1) JEDEC document JEP155 states that 500-V HBM allows safe manufacturing with a standard ESD control process.
- (2) JEDEC document JEP157 states that 250-V CDM allows safe manufacturing with a standard ESD control process.

6.3 Recommended Operating Conditions

over operating free-air temperature range (unless otherwise noted)

		MIN	NOM	MAX	UNIT
V _{IN}	Input voltage range	4.5		24	V
V _{OUT}	Output voltage range	V _{IN}		38	V
L1	Inductor, 600-kHz to 1-MHz switching frequency	10		22	μH
L1	Inductor, 280-kHz to 600-kHz switching frequency	22		47	μH
C _I	Input capacitor	1			μF
C _O	Output capacitor	1	4.7	10	μF
F _{PWM_O}	IFBx PWM dimming frequency - frequency programmable mode	0.1		22 ⁽¹⁾	KHz
F _{PWM_O}	IFBx PWM dimming frequency - direct PWM mode	0.1		50	KHz
F _{PWM_I}	PWM input signal frequency	0.1		22	KHz
F _{BOOST}	Boost regulator switching frequency	280		1000	KHz
T _A	Operating free-air temperature	–40		85	°C
T _J	Operating junction temperature	–40		125	°C

- (1) 5 μs min pulse on time.

6.4 Thermal Information

THERMAL METRIC ⁽¹⁾		TPS61183	
		RTJ	
		20 PINS	
			UNITS
R _{θJA}	Junction-to-ambient thermal resistance	39.9	°C/W
R _{θJC(top)}	Junction-to-case(top) thermal resistance	34.0	°C/W
R _{θJB}	Junction-to-board thermal resistance	9.9	°C/W
ψ _{JT}	Junction-to-top characterization parameter	0.6	°C/W
ψ _{JB}	Junction-to-board characterization parameter	9.5	°C/W
R _{θJC(bottom)}	Junction-to-case(bottom) thermal resistance	2	°C/W

(1) For more information about traditional and new thermal metrics, see [Semiconductor and IC Package Thermal Metrics](#).

6.5 Electrical Characteristics

V_{IN} = 12 V, PWM/EN = high, IFB current = 20 mA, IFB voltage = 500 mV, T_A = –40°C to 85°C, typical values are at T_A = 25°C (unless otherwise noted)

PARAMETER		TEST CONDITIONS	MIN	TYP	MAX	UNIT
SUPPLY CURRENT						
V _{IN}	Input voltage range		4.5		24	V
I _{q_VIN}	Operating quiescent current into V _{in}	Device enable, switching 1 MHz and no load, V _{IN} = 24 V			4	mA
VDDIO	VDDIO pin output voltage	I _{LOAD} = 5 mA	3		3.6	V
I _{SD}	Shutdown current	V _{IN} = 12 V, EN = low			11	μA
		V _{IN} = 24 V, EN = low			16	
V _{IN_UVLO}	V _{IN} undervoltage lockout threshold	V _{IN} ramp down			3.50	V
		V _{IN} ramp up			3.75	
V _{IN_Hys}	V _{IN} undervoltage lockout hysteresis			250		mV
PWM						
V _H	EN Logic high threshold	EN	2.1			V
V _L	EN Logic low threshold	EN			0.8	
V _H	PWM Logic high threshold	PWM	2.1			
V _L	PWM Logic low threshold	PWM			0.8	
R _{PD}	Pulldown resistor on PWM and EN		400	800	1600	kΩ
CURRENT REGULATION						
V _{ISET}	ISET pin voltage		1.204	1.229	1.253	V
K _{ISET}	Current multiplier			980		
I _{FB}	Current accuracy (average)	I _{ISET} = 20 μA, 0°C to 70°C	–2%		2%	
	Current accuracy (average)	I _{ISET} = 20 μA, –40°C to 85°C	–2.3%		2.3%	
K _m	(I _{max} – I _{min}) / I _{AVG}	I _{ISET} = 20 μA		1.3%		
I _{leak}	IFB pin leakage current	IFB voltage = 15 V, each pin		2	5	μA
		IFB voltage = 5 V, each pin		1	2	
I _{IFB_max}	Current sink max output current	IFB = 350 mV	30			mA
f _{dim}	PWM dimming frequency	R _{FPWM} = 9.09 kΩ		20		kHz

Electrical Characteristics (continued)

$V_{IN} = 12\text{ V}$, PWM/EN = high, IFB current = 20 mA, IFB voltage = 500 mV, $T_A = -40^\circ\text{C}$ to 85°C , typical values are at $T_A = 25^\circ\text{C}$ (unless otherwise noted)

PARAMETER		TEST CONDITIONS	MIN	TYP	MAX	UNIT
BOOST OUTPUT REGULATION						
V_{IFB_L}	Output voltage up threshold	Measured on $V_{IFB(min)}$		350		mV
V_{IFB_H}	Output voltage down threshold	Measured on $V_{IFB(min)}$		650		mV
POWER SWITCH						
R_{PWM_SW}	PWM FET on-resistance	$V_{IN} = 12\text{ V}$		0.25	0.35	Ω
I_{LN_NFET}	PWM FET leakage current	$V_{SW} = 40\text{ V}$, $T_A = 25^\circ\text{C}$			2	μA
OSCILLATOR						
f_{SW}	Oscillator frequency	$R_{FSW} = 499\text{ k}\Omega$	0.8	1	1.2	MHz
D_{max}	Maximum duty cycle	IFB = 0		94%		
OC, SC, OVP AND SS						
I_{LIM}	N-Channel MOSFET current limit	$D = D_{max}$	2		3	A
V_{CLAMP_TH}	Output voltage clamp program threshold		1.9	1.95	2	V
V_{OVP_IFB}	IFB overvoltage threshold	Measured on the IFBx pin, IFB on	12	13.5	15	V
FPO, FAULT						
V_{FPO_L}	FPO Logic low voltage	$I_{SOURCE} = 0.5\text{ mA}$			0.4	V
V_{FAULT_HIGH}	Fault high voltage	Measured as $V_{IN} - V_{FAULT}$		0.1		V
V_{FAULT_LOW}	Fault low voltage	Measured as $V_{IN} - V_{FAULT}$, Sink, 10 μA	6	8	10	V
I_{FAULT}	Maximum sink current	$V_{IN} - V_{FAULT} = 0\text{ V}$		20		μA
THERMAL SHUTDOWN						
$T_{shutdown}$	Thermal shutdown threshold			150		$^\circ\text{C}$
	Thermal shutdown hysteresis			15		

6.6 Typical Characteristics

Table 1. Table Of Graphs

TITLE	DESCRIPTION	FIGURE
Efficiency vs load current by output voltage	$V_{IN} = 12\text{ V}$, $V_{OUT} = 28\text{ V}$, 32 V , 36 V , $L = 10\text{ }\mu\text{H}$	Figure 18
Efficiency vs load current by input voltage	$V_{OUT} = 32\text{ V}$, $V_{IN} = 8\text{ V}$, 12 V , 24 V , $L = 10\text{ }\mu\text{H}$	Figure 19
Efficiency vs PWM duty	$V_{OUT} = 32\text{ V}$, $V_{IN} = 8\text{ V}$, 12 V , 24 V , $F_{DIM} = 200\text{ Hz}$, $L = 10\text{ }\mu\text{H}$, $R_{ISET} = 62\text{ k}\Omega$	Figure 20
Dimming linearity	$V_{OUT} = 32\text{ V}$, $V_{IN} = 8\text{ V}$, 12 V , 24 V , $F_{DIM} = 20\text{ KHz}$, $L = 10\text{ }\mu\text{H}$, $R_{ISET} = 62\text{ k}\Omega$	Figure 1
Dimming linearity	$V_{OUT} = 32\text{ V}$, $V_{IN} = 8\text{ V}$, 12 V , 24 V , $F_{DIM} = 200\text{ Hz}$, $L = 10\text{ }\mu\text{H}$, $R_{ISET} = 62\text{ k}\Omega$	Figure 2
Boost switching frequency	$V_{IN} = 12\text{ V}$, $V_{OUT} = 33.8\text{ V}$, $L = 10\text{ }\mu\text{H}$, $R_{ISET} = 62\text{ k}\Omega$	Figure 3
Programmable dimming frequency	$V_{IN} = 12\text{ V}$, $V_{OUT} = 33.8\text{ V}$, $L = 10\text{ }\mu\text{H}$, $R_{ISET} = 62\text{ k}\Omega$	Figure 4
Switch waveform	$V_{IN} = 8\text{ V}$, $V_{OUT} = 33.8\text{ V}$, $F_{DIM} = 20\text{ kHz}$, Duty = 100%, $L = 10\text{ }\mu\text{H}$, $R_{ISET} = 62\text{ k}\Omega$	Figure 5
Switch waveform	$V_{IN} = 12\text{ V}$, $V_{OUT} = 33.8\text{ V}$, $F_{DIM} = 20\text{ kHz}$, Duty = 100%, $L = 10\text{ }\mu\text{H}$, $R_{ISET} = 62\text{ k}\Omega$	Figure 6
Programmable PWM dimming $F_{DIM} = 200\text{Hz}$, duty = 50%	$V_{IN} = 12\text{ V}$, $V_{OUT} = 33.8\text{ V}$, $F_{DIM} = 20\text{ kHz}$, Duty = 50%, $L = 10\text{ }\mu\text{H}$, $R_{ISET} = 62\text{ k}\Omega$	Figure 7
Programmable PWM dimming $F_{DIM} = 20\text{KHz}$, duty = 50%	$V_{IN} = 12\text{ V}$, $V_{OUT} = 33.8\text{ V}$, $F_{DIM} = 20\text{ kHz}$, Duty = 50%, $L = 10\text{ }\mu\text{H}$, $R_{ISET} = 62\text{ k}\Omega$	Figure 8
Output ripple of programmable PWM dimming	$V_{IN} = 12\text{ V}$, $V_{OUT} = 33.8\text{ V}$, $F_{DIM} = 20\text{ kHz}$, Duty = 50%, $L = 10\text{ }\mu\text{H}$, $R_{ISET} = 62\text{ k}\Omega$	Figure 9
Output ripple of programmable PWM dimming	$V_{IN} = 12\text{ V}$, $V_{OUT} = 33.8\text{ V}$, $F_{DIM} = 20\text{ kHz}$, Duty = 70%, $L = 10\text{ }\mu\text{H}$, $R_{ISET} = 62\text{ k}\Omega$	Figure 10
Start-up waveform	$V_{IN} = 12\text{ V}$, $V_{OUT} = 33.8\text{ V}$, $F_{DIM} = 20\text{ kHz}$, Duty = 100%, $L = 10\text{ }\mu\text{H}$, $R_{ISET} = 62\text{ k}\Omega$	Figure 11
Start-up waveform	$V_{IN} = 12\text{ V}$, $V_{OUT} = 33.8\text{ V}$, $F_{DIM} = 20\text{ kHz}$, Duty = 50%, $L = 10\text{ }\mu\text{H}$, $R_{ISET} = 62\text{ k}\Omega$	Figure 12

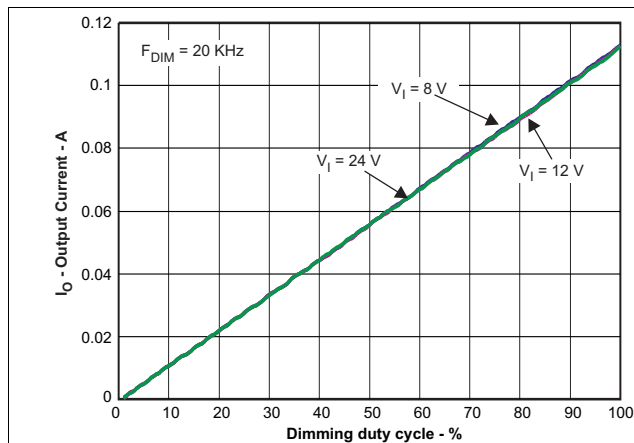
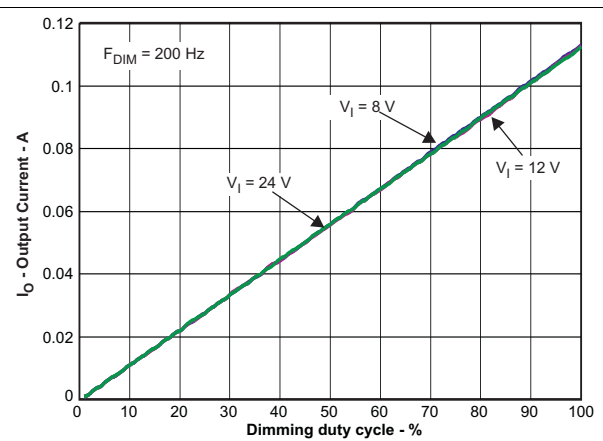
Figure 1. Dimming Linearity

Figure 2. Dimming Linearity

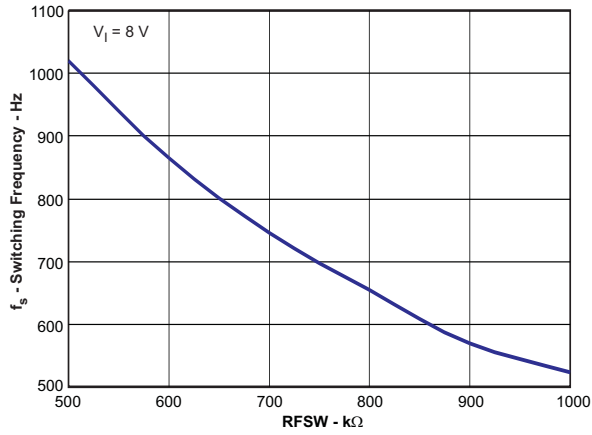

Figure 3. Boost Switching

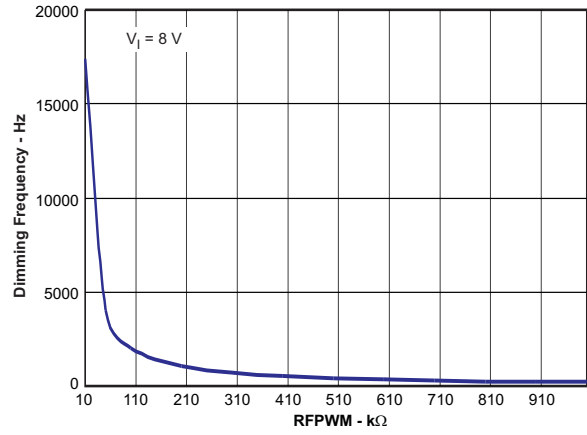

Figure 4. Programmable Dimming

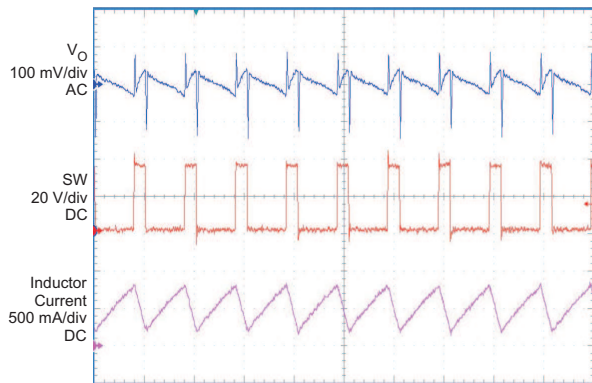

Figure 5. Switch Waveform

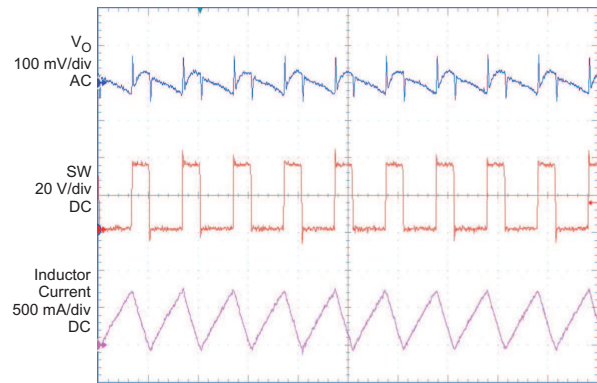

Figure 6. Programmable PWM Waveform

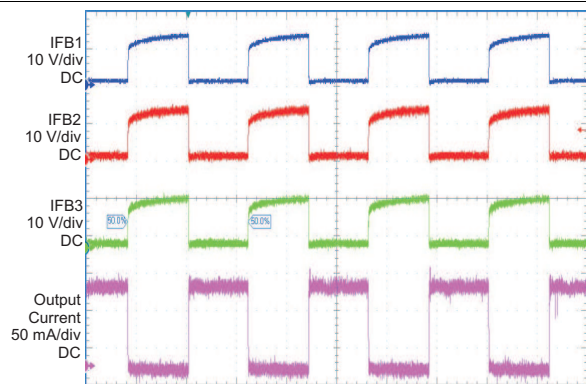

Figure 7. Programmable PWM Waveform

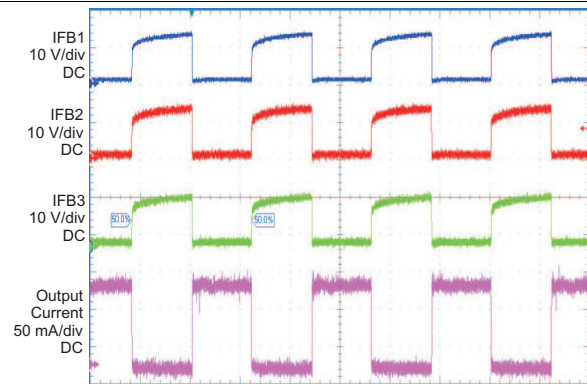

Figure 8. Programmable PWM Waveform

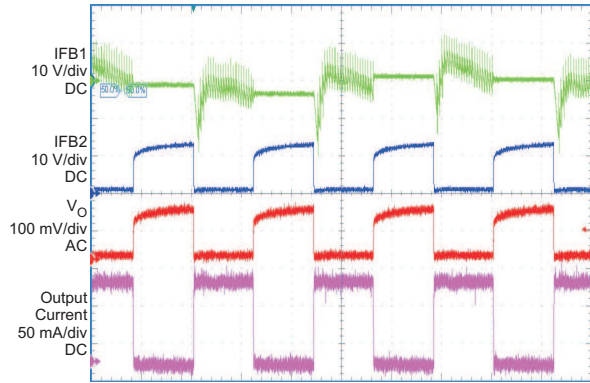

Figure 9. Output Ripple Waveform

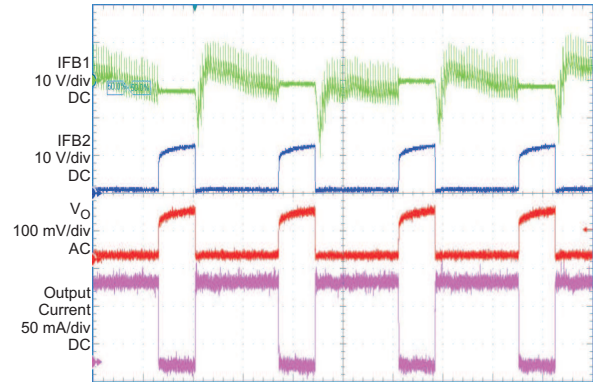

Figure 10. Output Ripple Waveform

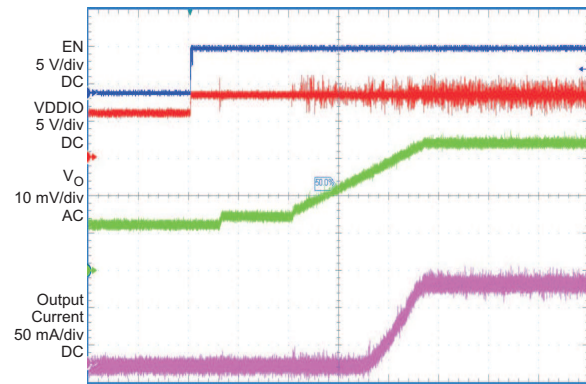

Figure 11. Start-Up Waveform

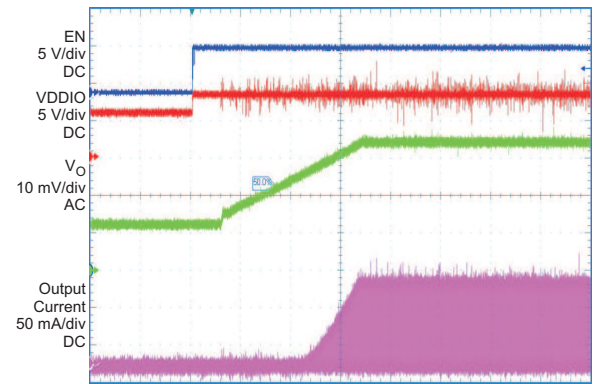

Figure 12. Start-Up Waveform

7 Detailed Description

7.1 Overview

The TPS61183 is a high-efficiency, high output-voltage, white-LED driver for notebook panel backlighting applications. The advantages of white LEDs compared to CCFL backlights are higher power efficiency and lower profile design. Due to the large number of white LEDs required to provide backlighting for medium-to-large display panels, the LEDs must be arranged in parallel strings of several LEDs in series. Therefore, the backlight driver for battery-powered systems is almost always a boost regulator with multiple current sink regulators. For normal operation there must be enough white LEDs in series to ensure the output voltage stays above the input voltage range. Having more white LEDs in series reduces the number of parallel strings, and therefore improves overall current matching. However, the efficiency of the boost regulator declines due to the need for high output voltage.

The TPS61183 device has integrated all of the key function blocks to power and control up to 60 white LEDs. The device includes a 40-V, 2-A boost regulator, six 30-mA current sink regulators, and a protection circuit for overcurrent, overvoltage, open LED, short LED, and output short-circuit failures. The device integrates programmable PWM dimming methods with the PWM interface to control output dimming frequency independently with input frequency. An optional direct PWM mode is user selectable through the RFPWM/MODE selection function.

7.2 Functional Block Diagram

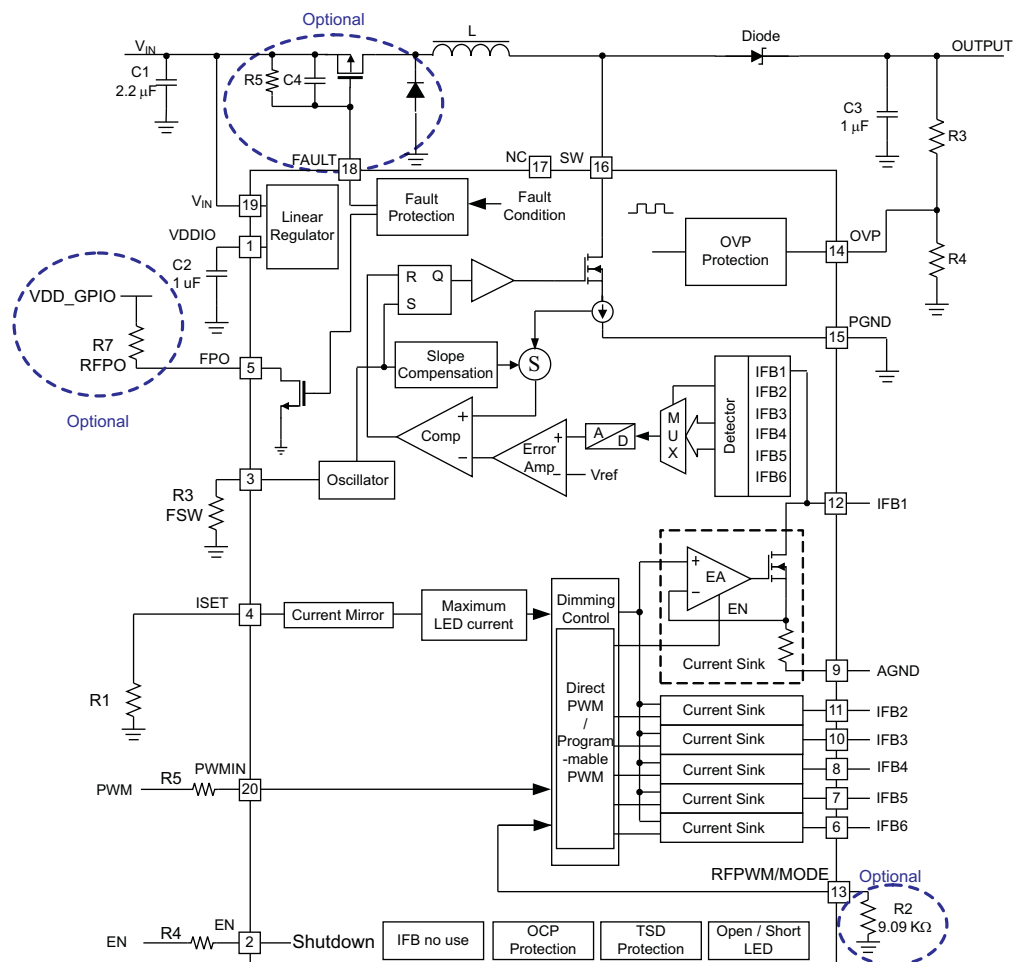

7.3 Feature Description

7.3.1 Supply Voltage

The TPS61183 device has a built-in linear regulator to supply the device analog and logic circuit. The VDDIO pin, output of the regulator, is connected to a 1- μ F bypass capacitor for the regulator to be controlled in a stable loop. VDDIO does not have high current sourcing capability for external use but it can be tied to the EN pin for start-up.

7.3.2 Boost Regulator and Programmable Switch Frequency (FSCLT)

The fixed-frequency PWM boost converter uses current-mode control and has integrated loop compensation. The internal compensation ensures stable output over the full input and output voltage ranges assuming the recommended inductance and output capacitance values in [Equation 1](#) are used. The output voltage of the boost regulator is automatically set by the device to minimize voltage drop across the IFB pins. The device regulates the lowest IFB pin to 350 mV and constantly adjusts the boost output voltage to account for any changes in LED forward voltages. If the input voltage is higher than the sum of the white LED forward voltage drops (for example, at low duty cycles), the boost converter is not able to regulate the output due to its minimum duty cycle limitation. In this case, increase the number of WLEDs in series or include series ballast resistors in order to provide enough headroom for the converter to boost the output voltage. Because the TPS61183 integrates a 40-V, 2-A power MOSFET, the boost converter can provide up to a 38-V output voltage.

The TPS61183 switching frequency can be programmed between 280 kHz to 1 MHz by the resistor value on the FSW pin according to [Equation 1](#):

$$F_{SW} = \frac{5 \times 10^{11}}{R_{FSW}}$$

where

- R_{FSW} = FSW pin resistor (1)

See [Figure 3](#) for boost converter switching frequency adjustment resistor R_{FSW} selection.

The adjustable switching frequency feature provides the user with the flexibility of choosing the switching frequency. A faster switching frequency allows for an inductor with smaller inductance and footprint while a slower switching frequency could potentially yield higher efficiency due to lower switching losses. Use [Equation 1](#) or refer to [Table 2](#) to select the correct value:

Table 2. R_{FSW} Recommendations

R_{FLCT}	f_{sw}
833 k Ω	600 KHz
625 k Ω	800 KHz
499 k Ω	1 MHz

7.3.3 LED Current Sinks

The six current-sink regulators embedded in the TPS61183 can be collectively configured to provide up to a maximum of 30 mA each. These six specialized current sinks are accurate to within $\pm 2\%$ max for currents at 20 mA, with a string-to-string difference of $\pm 1.5\%$ typical.

The IFB current must be programmed to the highest WLED current expected using the ISETH pin resistor and [Equation 2](#).

$$I_{FB} = \frac{V_{ISETH}}{R_{ISETH}} \times K_{ISET}$$

where

- K_{ISET} = 980 (current multiple)
- V_{ISETH} = 1.229 V (ISETH pin voltage)
- R_{ISETH} = ISETH pin resistor (2)

7.3.4 Enable and Start-Up

The internal regulator which provides VDDIO wakes up as soon as V_{IN} is applied even when EN is low. This allows the device to start when EN is tied to the VDDIO pin; however, VDDIO does not come to full regulation until EN is high. The TPS61183 checks the status of all current feedback channels and shuts down any unused feedback channels. TI recommends shorting the unused channels to ground for faster start-up.

After the device is enabled, if the PWMIN pin is left floating, the output voltage of the TPS61183 regulates to the minimum output voltage. Once the device detects a voltage on the PWMIN pin, the TPS61183 begins to regulate the IFB pin current, as pre-set per the ISETH pin resistor, according to the duty cycle of the signal on the PWMIN pin. The boost converter output voltage rises to the appropriate level to accommodate the sum of the white LED string with the highest forward voltage drops plus the headroom of the current sink at that current.

Pulling the EN pin low shuts down the device, resulting in the device consuming less than 11 μA in shutdown mode.

7.3.5 IFB Pin Unused

The TPS61183 has open/short string detection. For an unused IFB string, simply short it to ground or leave it open. TI recommends shorting unused IFB pins to ground for faster start-up.

7.4 Device Functional Modes

7.4.1 Brightness Dimming Control

The TPS61183 has programmable PWM dimming control with the PWM control interface.

The internal decoder block detects duty cycle information from the input PWM signal, saves it in an eight bit register and delivers it to the output PWM dimming control circuit. The output PWM dimming control circuit turns on/off six output current sinks at the PWM frequency set by RFPWM and the duty cycle from the decoder block.

The TPS61183 also has direct PWM dimming control with the PWM control interface. In direct PWM mode, each current sink turns on/off at the same frequency and duty cycle as the input PWM signal. See [Mode Selection – Programmable PWM Dimming or Direct PWM Dimming](#) for dimming mode selection.

When in programmable PWM mode, TI recommends inserting a series resistor of 10-k Ω to 20-k Ω value close to PWMIN pin. This resistor together with an internal capacitor forms a low pass R-C filter with 30-ns to 60-ns time constant. This prevents possible high frequency noises being coupled into the input PWM signal and causing interference to the internal duty cycle decoding circuit. However, it is not necessary for direct PWM mode because the duty cycle decoding circuit is disabled during the direct PWM mode.

7.4.2 Adjustable PWM Dimming Frequency and Mode Selection (R_FPWM/MODE)

The TPS61183 can operate in programmable mode or direct PWM mode. Tying the RFPWM/MODE pin to VDDIO forces the device to operate in direct PWM mode. Alternatively, a resistor between the RFPWM/MODE pin and ground sets the device into programmable mode with the value of the resistor determines the PWM dimming frequency. Use [Equation 3](#) or refer to [Table 3](#) to select the correct value:

$$F_{\text{DIM}} = \frac{1.818 \times 10^8}{R_{\text{FPWM}}}$$

where

- R_{FPWM} = RFPWM pin resistor

(3)

Table 3. R_{FPWM} Recommendations

R_{FPWM}	F_{DIM}
866 k Ω	210 Hz
437 k Ω	420 Hz
174 k Ω	1.05 kHz
9.09 k Ω	20 kHz

7.4.3 Mode Selection – Programmable PWM Dimming or Direct PWM Dimming

The programmable dimming method or direct PWM dimming method can be selected through the RFPWM/MODE pin. By attaching an external resistor to the RFPWM/MODE pin, the default programmable PWM mode can be selected. To select direct PWM mode, the RFPWM/MODE pin needs to be tied to the VDDIO pin. The RFPWM/MODE pin can be noise sensitive when R2 has high impedance. In this case, careful layout or a parallel bypassing capacitor improves noise sensitivity but the value of the parallel capacitor may not exceed 33 pF for oscillator stability.

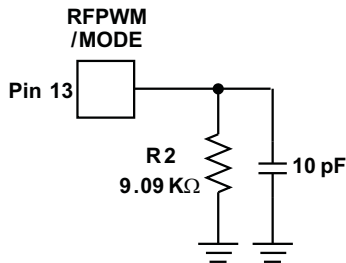

Figure 13. Programmable Dimming Mode Selection

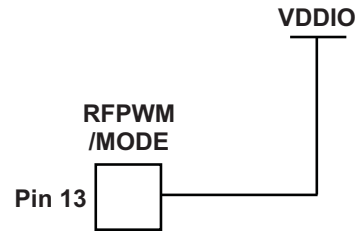

Figure 14. Direct PWM Dimming Mode Selection

7.4.4 Direct PWM Dimming

In direct PWM mode, all current feedback channels are turned on and off and are synchronized with the input PWM signal.

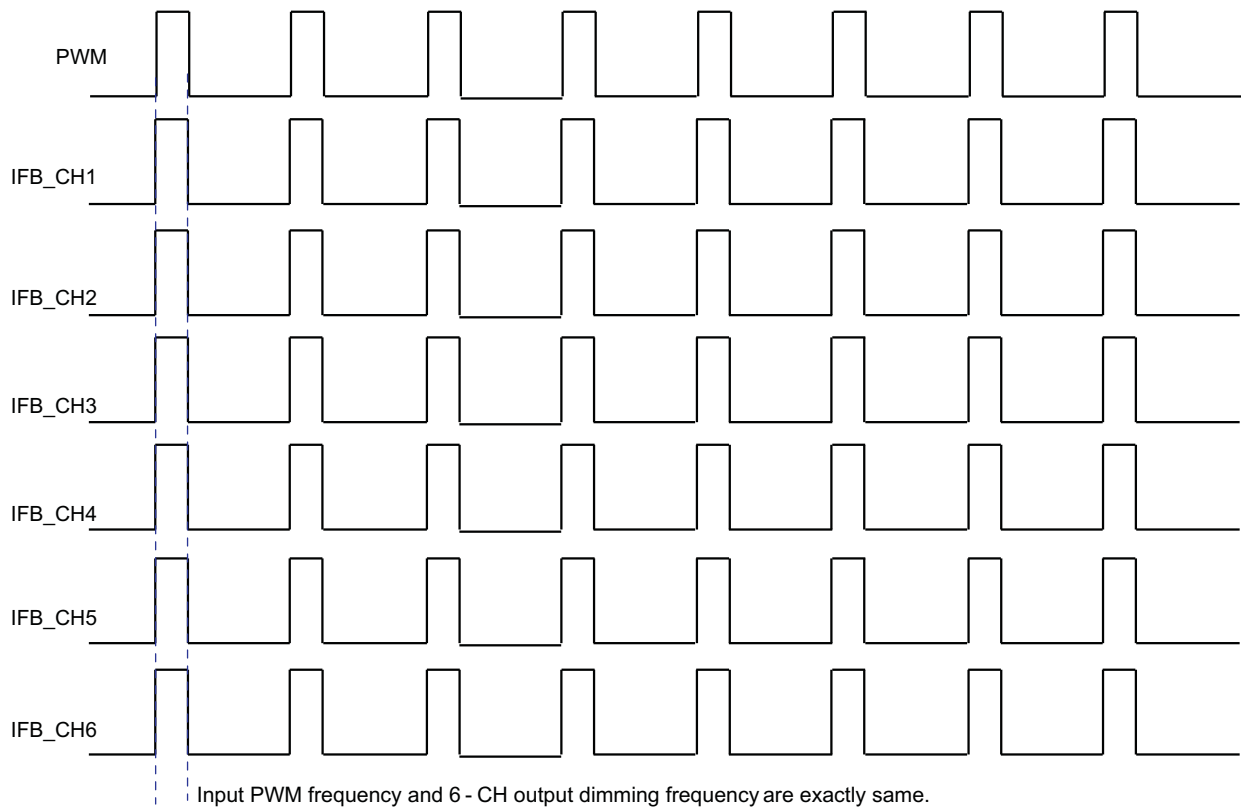

Figure 15. Direct PWM Dimming Timing Diagram

7.4.5 Overvoltage Clamp and Voltage Feedback (OVP/FB)

The overvoltage clamp prevents the boost converter from being damaged due to overvoltage in the event there are no LEDs or failed LEDs in the feedback path. The correct divider ratio is important for optimum operation of the TPS61183. It can be noise sensitive if R_{upper} and R_{down} have high impedance. Careful layout is required. Also, choose lower resistance values for R_{upper} and R_{down} when power dissipation allows. Use the following guidelines to choose the divider value:

1. Determine the maximum output voltage, V_O , for the system according to the number of series WLEDs.
2. Select an R_{upper} resistor value (1 M Ω for a typical application; a lower value such as 100 k Ω for a noisy environment).
3. Calculate R_{down} using Equation 4.

$$V_{OVP} = \left(\frac{R_{upper}}{R_{down}} + 1 \right) \times V_{OV_TH}$$

where

- $V_{OV_TH} = 1.95 \text{ V}$ (4)

When the device detects that the OVP pin exceeds 1.95 V typical, indicating that the output voltage is over the set threshold point, the OVP circuitry clamps the output voltage to the set threshold.

7.4.6 Current Sink Open Protection

For the TPS61183, if one of the WLED strings is open, the device automatically detects and disables that string. The device detects the open WLED string by sensing no current in the corresponding IFB pin. As a result, the device deactivates the open IFB pin and removes it from the voltage feedback loop. Subsequently, the output voltage drops and is regulated to the minimum voltage required for the connected WLED strings. The IFB current of the connected WLED strings remains in regulation.

If any IFB pin voltage exceeds the IFB overvoltage threshold (13.5 V typical), the device turns off the corresponding current sink and removes this IFB pin from the regulation loop. The current regulation of the remaining IFB pins is not affected. This condition often occurs when there are several shorted WLEDs in one string. WLED mismatch typically does not create large voltage differences among WLED strings.

The device only shuts down if it detects that all of the WLED strings are open. If an open string is reconnected again, a power-on reset (POR) or EN pin toggling is required to reactivate a previously deactivated string.

7.4.7 Overcurrent and Short-Circuit Protection

The TPS61183 has a pulse-by-pulse over-current limit of 2 A (minimum). The PWM switch turns off when the inductor current reaches this current threshold. The PWM switch remains off until the beginning of the next switching cycle. This protects the device and external components during on overload conditions. When there is a sustained overcurrent condition, the device turns off and requires a POR or EN pin toggling to restart. Under severe overload and/or short-circuit conditions, the boost output voltage can be pulled below the required regulated voltage to keep all of the white LEDs operating. Under this condition, the current flows directly from input to output through the inductor and Schottky diode. To protect the TPS61183, the device shuts down immediately. The device restarts after input POR or EN pin toggling.

7.4.8 Thermal Protection

When the junction temperature of the TPS61183 device is over 150°C, the thermal protection circuit is triggered and shuts down the device immediately. Only a POR or EN pin toggling clears the protection and restarts the device.

7.4.9 Programmable PWM Dimming

F_{DIM} is the PWM dimming frequency which is determined by the value of R_{FPWM} on the RFPWM/MODE pin. Figure 16 provides the detailed timing diagram of the programmable PWM dimming mode.

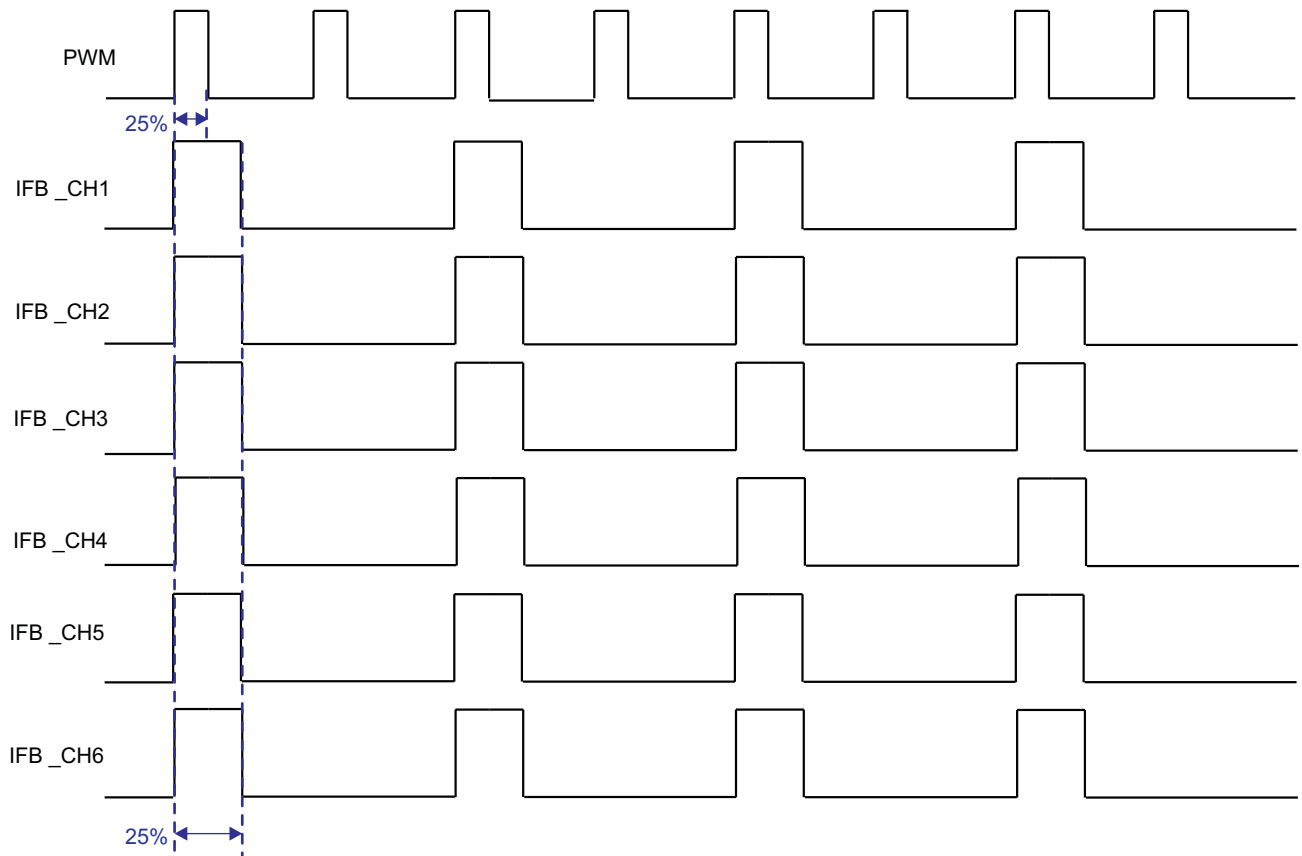

Figure 16. Programmable PWM Dimming Timing Diagram

8 Application and Implementation

NOTE

Information in the following applications sections is not part of the TI component specification, and TI does not warrant its accuracy or completeness. TI's customers are responsible for determining suitability of components for their purposes. Customers should validate and test their design implementation to confirm system functionality.

8.1 Application Information

The TPS61183 provides a high-performance LED lighting solution for tablets, notebooks, monitors, and a variety of industrial designs. The device can drive 6 strings of 10 series LEDs in a compact and high efficient solution. The TPS61183 provides a gate driver to an external P channel MOSFET which can be turned off during device shutdown or fault condition.

8.2 Typical Application

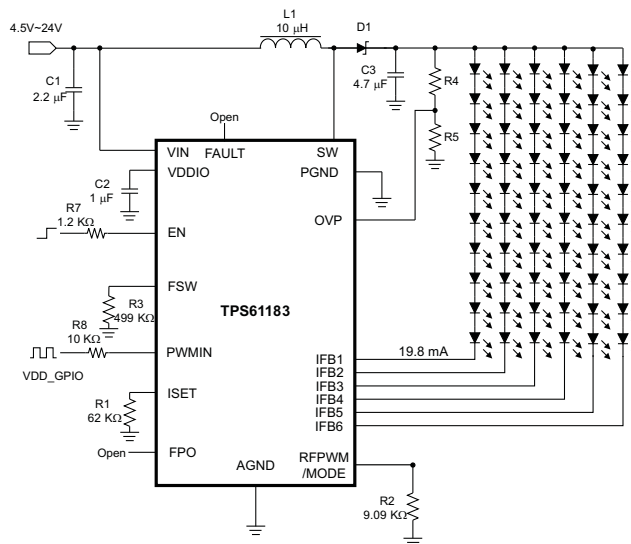

Figure 17. TPS61183 Typical Application

8.2.1 Design Requirements

For typical white-LED driver applications, use the parameters listed in [Table 4](#).

Table 4. Design Parameters

DESIGN PARAMETER	EXAMPLE VALUE
Input voltage	4.5 V to 24 V
Output voltage	38 V (maximum)
LED string current	30 mA (maximum)
Switching frequency	280 kHz to 1 MHz

8.2.2 Detailed Design Procedure

8.2.2.1 Inductor Selection

Because selection of the inductor affects power supply steady-state operation, transient behavior, and loop stability, the inductor is the most important component in switching-power-regulator design. There are three specifications most important to the performance of the inductor: inductor value, DC resistance, and saturation current. The TPS61183 is designed to work with inductor values between 10 μH and 47 μH . A 10- μH inductor is typically available in a smaller or lower profile package, while a 47- μH inductor may produce higher efficiency due to a slower switching frequency and/or lower inductor ripple. If the boost output current is limited by the overcurrent protection of the device, using a 10- μH inductor and the highest switching frequency maximizes controller output current capability.

Internal loop compensation for PWM control is optimized for the external component values, including typical tolerances, recommended in [Table 5](#). Inductor values can have $\pm 20\%$ tolerance with no current bias. When the inductor current approaches saturation level, its inductance can decrease 20% to 35% from the 0-A value depending on how the inductor vendor defines saturation. In a boost regulator, the inductor DC current can be calculated with [Equation 5](#).

$$I_{\text{DC}} = \frac{V_{\text{out}} \times I_{\text{out}}}{V_{\text{in}} \times \eta}$$

where

- V_{OUT} = boost output voltage
- I_{OUT} = boost output current
- V_{IN} = boost input voltage
- η = power conversion efficiency, use 90% for TPS61183 applications (5)

The inductor current peak-to-peak ripple can be calculated with [Equation 6](#).

$$I_{\text{PP}} = \frac{1}{L \times \left(\frac{1}{V_{\text{out}} - V_{\text{in}}} + \frac{1}{V_{\text{in}}} \right) \times F_{\text{S}}}$$

where

- I_{PP} = inductor peak-to-peak ripple
- L = inductor value
- F_{S} = switching frequency
- V_{OUT} = boost output voltage
- V_{IN} = boost input voltage (6)

Therefore, the peak current seen by the inductor is calculated with [Equation 7](#).

$$I_{\text{P}} = I_{\text{DC}} + \frac{I_{\text{PP}}}{2} \tag{7}$$

Select an inductor with a saturation current over the calculated peak current. To calculate the worst-case inductor peak current, use the minimum input voltage, maximum output voltage, and maximum load current.

Regulator efficiency is dependent on the resistance of its high current path and switching losses associated with the PWM switch and power diode. Although the TPS61183 device has optimized the internal switch resistance, the overall efficiency is affected by the inductor DC resistance (DCR). Lower DCR improves efficiency. However, there is a trade-off between DCR and inductor footprint; furthermore, shielded inductors typically have higher DCR than unshielded ones. [Table 5](#) lists the recommended inductors.

Table 5. Recommended Inductors for TPS61183

	L (μH)	DCR (mΩ)	I _{SAT} (A)	Size (L x W x H mm)
TOKO				
A915AY – 4R7M	4.7	38	1.87	5.2 x 5.2 x 3.0
A915AY – 100M	10	75	1.24	5.2 x 5.2 x 3.0
TDK				
SLF6028T – 4R7N1R6	4.7	38	1.87	5.2 x 5.2 x 3.0
SLF6028T – 4R7N1R6	10	75	1.24	5.2 x 5.2 x 3.0

8.2.2.2 Output Capacitor Selection

The output capacitor is mainly selected to meet the requirement for output ripple and loop stability. This ripple voltage is related to the capacitance of the capacitor and its equivalent series resistance (ESR). Assuming a capacitor with zero ESR, the minimum capacitance needed for a given ripple can be calculated with [Equation 8](#):

$$C_{out} = \frac{(V_{out} - V_{in}) \times I_{out}}{V_{out} \times F_s \times V_{ripple}}$$

where

- V_{ripple} = peak-to-peak output ripple (8)

. The additional part of the ripple caused by ESR is calculated using:

Additionally, it is sometimes necessary to be aware of the output ripple voltage due to the ESR of the output capacitor where V_{ripple_ESR} = I_{OUT} × RESR. Due to its low ESR, V_{ripple_ESR} can be neglected for ceramic capacitors, but must be considered if tantalum or electrolytic capacitors are used. The controller output voltage also ripples due to the load transient that occurs during PWM dimming. The TPS61183 adopts a patented technology to limit this type of output ripple even with the minimum recommended output capacitance. In a typical application, the output ripple is less than 250 mV during PWM dimming with a 4.7-μF output capacitor. However, the output ripple decreases with higher output capacitances.

8.2.2.3 Isolation FET Selection

The TPS61183 provides a gate driver to an external P channel MOSFET which can be turned off during device shutdown or fault condition. This MOSFET can provide a true shutdown function and also protect the battery from output short-circuit conditions. The source of the PMOS must be connected to the input, and a pullup resistor is required between the source and gate of the FET to keep the FET off during device shutdown. To turn on the isolation FET, the FAULT pin is pulled low and clamped at 8 V below the VBAT pin voltage. During device shutdown or fault condition, the isolation FET is turned off, and the input voltage is applied on the isolation MOSFET. During a short-circuit condition, the catch diode (D2 in the typical application circuit) is forward biased when the isolation FET is turned off. The drain of the isolation FET swings below ground. The voltage across the isolation FET can be momentarily greater than the input voltage. Therefore, select a 30-V PMOS for a 24-V maximum input. The on resistance of the FET has a large impact on power conversion efficiency because the FET carries the input voltage. Select a MOSFET with R_{ds(on)} less than 100 mΩ to limit the power losses.

8.2.3 Application Curves

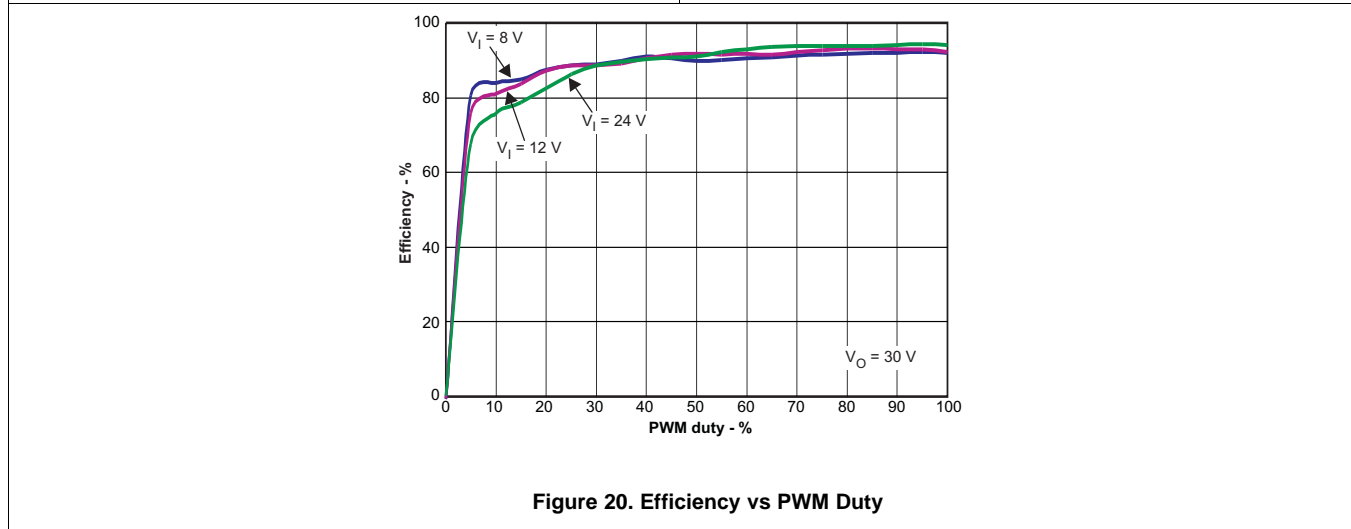
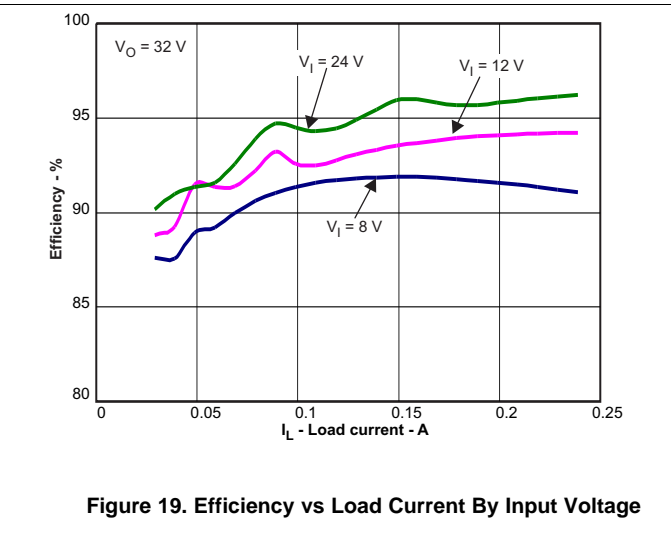
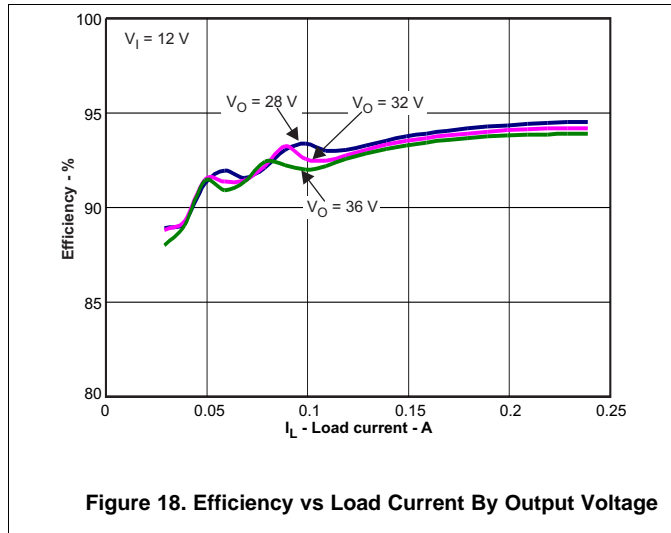

9 Power Supply Recommendations

The TPS61183 device requires a single-supply input voltage able to supply enough current for a given application. This voltage can range between 4.5 V to 24 V.

10 Layout

10.1 Layout Guidelines

As for all switching power supplies, especially those providing high current and using high switching frequencies, layout is an important design step. If layout is not carefully done, the regulator could show instability as well as EMI problems. Therefore, use wide and short traces for high-current paths. The input capacitor, C1 in the typical application circuit (see [Typical Programmable PWM-Mode Application](#)), must be close to the VIN pin, as well as to the GND pin in order to reduce the input ripple detected by the device. The input capacitor, C1 in the typical application circuit, must also be placed close to the inductor. C2 is the filter and noise decoupling capacitor for the internal linear regulator powering the internal digital circuits. Place C2 as close as possible between the VDDIO and AGND pins to prevent any noise insertion to the digital circuits. The SW pin carries high current with fast rising and falling edges. Therefore, keep the connection between the pin to the inductor and Schottky diode as short and wide as possible. It is also beneficial to have the ground of the output capacitor C3 close to the PGND pin as there is a large ground return current flowing between them. When laying out signal grounds, TI recommends using short traces separated from power ground traces, connected together at a single point, for example on the thermal pad. The thermal pad must be soldered on to the PCB and connected to the GND pin of the device. An additional thermal via can significantly improve device power dissipation.

10.2 Layout Example

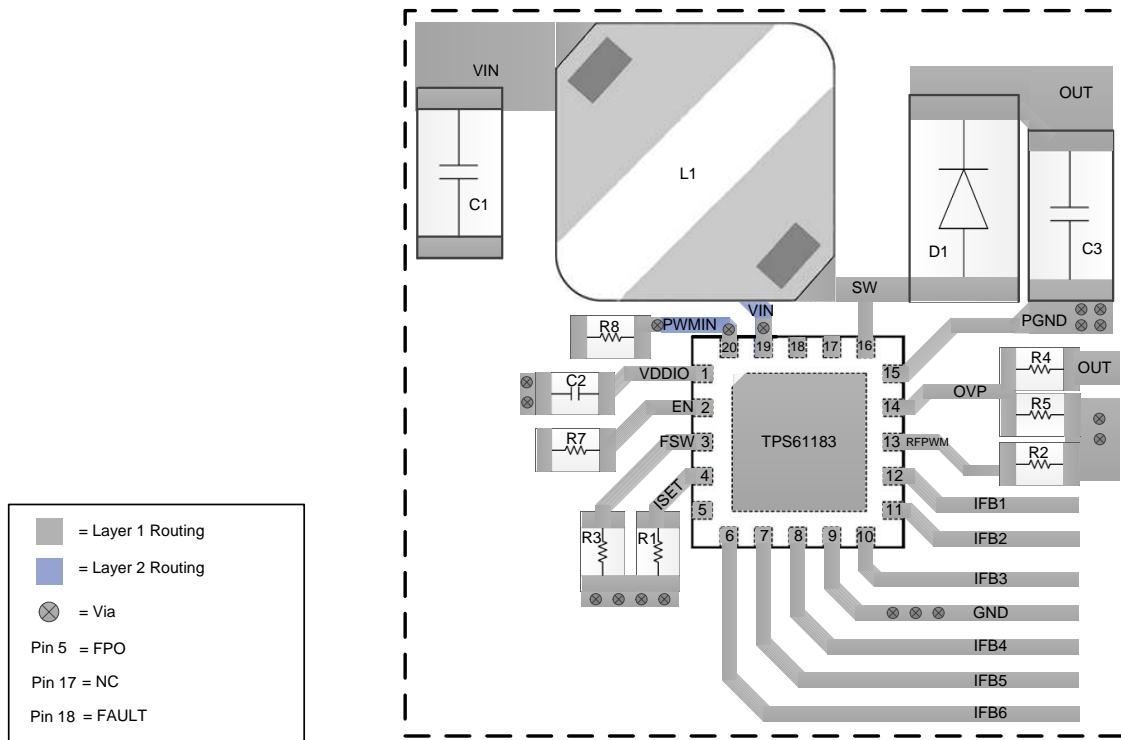

Figure 21. TPS61183 Layout

11 Device and Documentation Support

11.1 Device Support

11.1.1 Third-Party Products Disclaimer

TI'S PUBLICATION OF INFORMATION REGARDING THIRD-PARTY PRODUCTS OR SERVICES DOES NOT CONSTITUTE AN ENDORSEMENT REGARDING THE SUITABILITY OF SUCH PRODUCTS OR SERVICES OR A WARRANTY, REPRESENTATION OR ENDORSEMENT OF SUCH PRODUCTS OR SERVICES, EITHER ALONE OR IN COMBINATION WITH ANY TI PRODUCT OR SERVICE.

11.2 Receiving Notification of Documentation Updates

To receive notification of documentation updates, navigate to the device product folder on ti.com. In the upper right corner, click on *Alert me* to register and receive a weekly digest of any product information that has changed. For change details, review the revision history included in any revised document.

11.3 Community Resources

The following links connect to TI community resources. Linked contents are provided "AS IS" by the respective contributors. They do not constitute TI specifications and do not necessarily reflect TI's views; see TI's [Terms of Use](#).

TI E2E™ Online Community *TI's Engineer-to-Engineer (E2E) Community*. Created to foster collaboration among engineers. At e2e.ti.com, you can ask questions, share knowledge, explore ideas and help solve problems with fellow engineers.

Design Support *TI's Design Support* Quickly find helpful E2E forums along with design support tools and contact information for technical support.

11.4 Trademarks

PowerPAD, E2E are trademarks of Texas Instruments.
All other trademarks are the property of their respective owners.

11.5 Electrostatic Discharge Caution



These devices have limited built-in ESD protection. The leads should be shorted together or the device placed in conductive foam during storage or handling to prevent electrostatic damage to the MOS gates.

11.6 Glossary

[SLYZ022](#) — *TI Glossary*.

This glossary lists and explains terms, acronyms, and definitions.

12 Mechanical, Packaging, and Orderable Information

The following pages include mechanical, packaging, and orderable information. This information is the most current data available for the designated devices. This data is subject to change without notice and revision of this document. For browser-based versions of this data sheet, refer to the left-hand navigation.

PACKAGING INFORMATION

Orderable Device	Status (1)	Package Type	Package Drawing	Pins	Package Qty	Eco Plan (2)	Lead/Ball Finish (6)	MSL Peak Temp (3)	Op Temp (°C)	Device Marking (4/5)	Samples
TPS61183RTJR	ACTIVE	QFN	RTJ	20	3000	Green (RoHS & no Sb/Br)	CU NIPDAU	Level-2-260C-1 YEAR	-40 to 85	TPS 61183	Samples
TPS61183RTJT	ACTIVE	QFN	RTJ	20	250	Green (RoHS & no Sb/Br)	CU NIPDAU	Level-2-260C-1 YEAR	-40 to 85	TPS 61183	Samples

(1) The marketing status values are defined as follows:

ACTIVE: Product device recommended for new designs.

LIFEBUY: TI has announced that the device will be discontinued, and a lifetime-buy period is in effect.

NRND: Not recommended for new designs. Device is in production to support existing customers, but TI does not recommend using this part in a new design.

PREVIEW: Device has been announced but is not in production. Samples may or may not be available.

OBsolete: TI has discontinued the production of the device.

(2) Eco Plan - The planned eco-friendly classification: Pb-Free (RoHS), Pb-Free (RoHS Exempt), or Green (RoHS & no Sb/Br) - please check <http://www.ti.com/productcontent> for the latest availability information and additional product content details.

TBD: The Pb-Free/Green conversion plan has not been defined.

Pb-Free (RoHS): TI's terms "Lead-Free" or "Pb-Free" mean semiconductor products that are compatible with the current RoHS requirements for all 6 substances, including the requirement that lead not exceed 0.1% by weight in homogeneous materials. Where designed to be soldered at high temperatures, TI Pb-Free products are suitable for use in specified lead-free processes.

Pb-Free (RoHS Exempt): This component has a RoHS exemption for either 1) lead-based flip-chip solder bumps used between the die and package, or 2) lead-based die adhesive used between the die and leadframe. The component is otherwise considered Pb-Free (RoHS compatible) as defined above.

Green (RoHS & no Sb/Br): TI defines "Green" to mean Pb-Free (RoHS compatible), and free of Bromine (Br) and Antimony (Sb) based flame retardants (Br or Sb do not exceed 0.1% by weight in homogeneous material)

(3) MSL, Peak Temp. - The Moisture Sensitivity Level rating according to the JEDEC industry standard classifications, and peak solder temperature.

(4) There may be additional marking, which relates to the logo, the lot trace code information, or the environmental category on the device.

(5) Multiple Device Markings will be inside parentheses. Only one Device Marking contained in parentheses and separated by a "~" will appear on a device. If a line is indented then it is a continuation of the previous line and the two combined represent the entire Device Marking for that device.

(6) Lead/Ball Finish - Orderable Devices may have multiple material finish options. Finish options are separated by a vertical ruled line. Lead/Ball Finish values may wrap to two lines if the finish value exceeds the maximum column width.

Important Information and Disclaimer: The information provided on this page represents TI's knowledge and belief as of the date that it is provided. TI bases its knowledge and belief on information provided by third parties, and makes no representation or warranty as to the accuracy of such information. Efforts are underway to better integrate information from third parties. TI has taken and continues to take reasonable steps to provide representative and accurate information but may not have conducted destructive testing or chemical analysis on incoming materials and chemicals. TI and TI suppliers consider certain information to be proprietary, and thus CAS numbers and other limited information may not be available for release.

In no event shall TI's liability arising out of such information exceed the total purchase price of the TI part(s) at issue in this document sold by TI to Customer on an annual basis.

TAPE AND REEL INFORMATION



QUADRANT ASSIGNMENTS FOR PIN 1 ORIENTATION IN TAPE



*All dimensions are nominal

Device	Package Type	Package Drawing	Pins	SPQ	Reel Diameter (mm)	Reel Width W1 (mm)	A0 (mm)	B0 (mm)	K0 (mm)	P1 (mm)	W (mm)	Pin1 Quadrant
TPS61183RTJR	QFN	RTJ	20	3000	330.0	12.4	4.25	4.25	1.15	8.0	12.0	Q2
TPS61183RTJR	QFN	RTJ	20	3000	330.0	12.4	4.25	4.25	1.15	8.0	12.0	Q2
TPS61183RTJT	QFN	RTJ	20	250	180.0	12.4	4.25	4.25	1.15	8.0	12.0	Q2
TPS61183RTJT	QFN	RTJ	20	250	180.0	12.4	4.25	4.25	1.15	8.0	12.0	Q2

TAPE AND REEL BOX DIMENSIONS



*All dimensions are nominal

Device	Package Type	Package Drawing	Pins	SPQ	Length (mm)	Width (mm)	Height (mm)
TPS61183RTJR	QFN	RTJ	20	3000	367.0	367.0	35.0
TPS61183RTJR	QFN	RTJ	20	3000	367.0	367.0	35.0
TPS61183RTJT	QFN	RTJ	20	250	210.0	185.0	35.0
TPS61183RTJT	QFN	RTJ	20	250	210.0	185.0	35.0

MECHANICAL DATA

RTJ (S-PWQFN-N20)

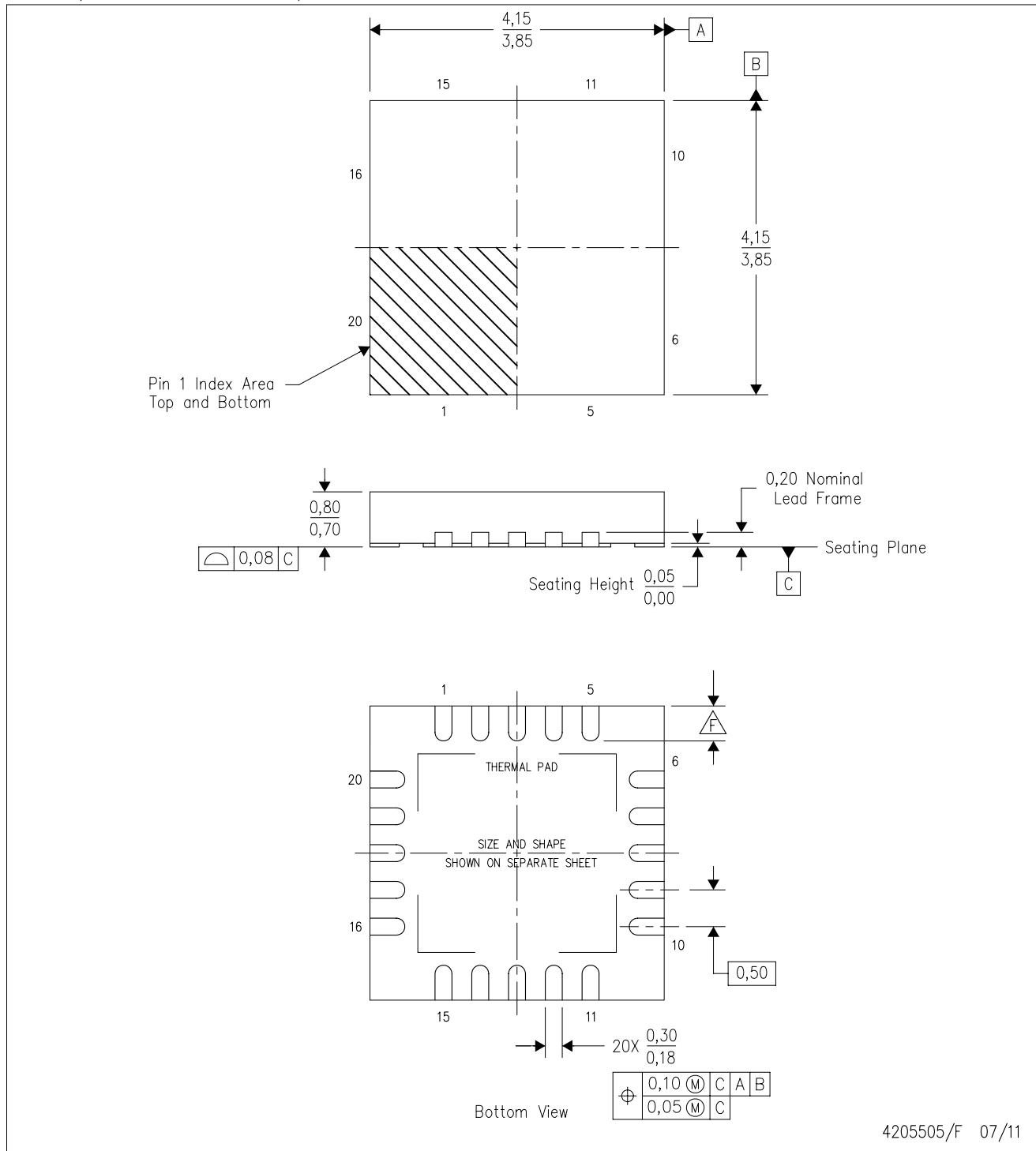
PLASTIC QUAD FLATPACK NO-LEAD



4205505/F 07/11

- NOTES:
- All linear dimensions are in millimeters. Dimensioning and tolerancing per ASME Y14.5-1994.
 - This drawing is subject to change without notice.
 - QFN (Quad Flatpack No-Lead) package configuration.
 - The package thermal pad must be soldered to the board for thermal and mechanical performance.
 - See the additional figure in the Product Data Sheet for details regarding the exposed thermal pad features and dimensions.
 - Check thermal pad mechanical drawing in the product datasheet for nominal lead length dimensions.

RTJ (S-PWQFN-N20)

PLASTIC QUAD FLATPACK NO-LEAD

THERMAL INFORMATION

This package incorporates an exposed thermal pad that is designed to be attached directly to an external heatsink. The thermal pad must be soldered directly to the printed circuit board (PCB). After soldering, the PCB can be used as a heatsink. In addition, through the use of thermal vias, the thermal pad can be attached directly to the appropriate copper plane shown in the electrical schematic for the device, or alternatively, can be attached to a special heatsink structure designed into the PCB. This design optimizes the heat transfer from the integrated circuit (IC).

For information on the Quad Flatpack No-Lead (QFN) package and its advantages, refer to Application Report, QFN/SON PCB Attachment, Texas Instruments Literature No. SLUA271. This document is available at www.ti.com.

The exposed thermal pad dimensions for this package are shown in the following illustration.

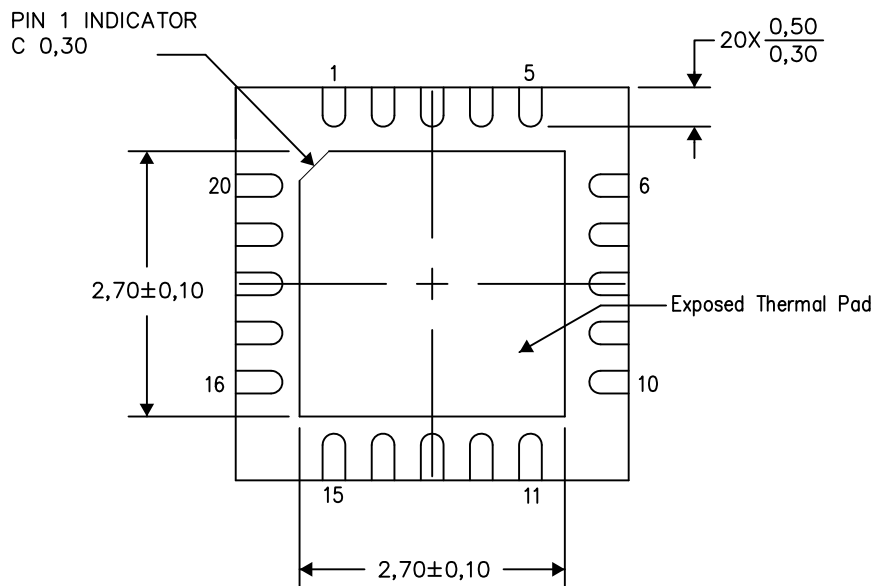

Bottom View

Exposed Thermal Pad Dimensions

4206256-2/V 05/15

NOTE: All linear dimensions are in millimeters

RTJ (S-PWQFN-N20)

PLASTIC QUAD FLATPACK NO-LEAD

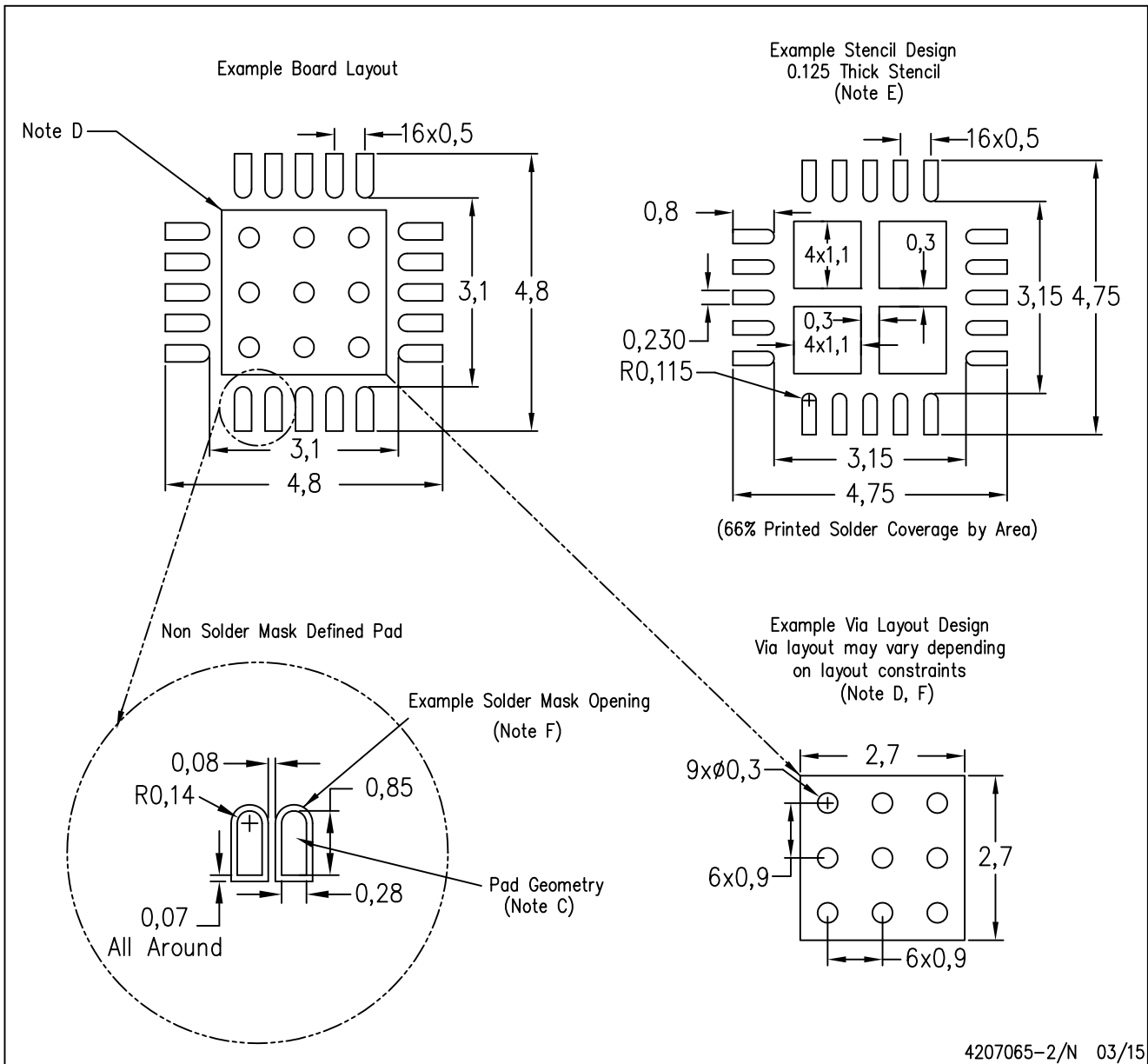

- NOTES:
- A. All linear dimensions are in millimeters.
 - B. This drawing is subject to change without notice.
 - C. Publication IPC-7351 is recommended for alternate designs.
 - D. This package is designed to be soldered to a thermal pad on the board. Refer to Application Note, Quad Flat-Pack Packages, Texas Instruments Literature No. SLUA271, and also the Product Data Sheets for specific thermal information, via requirements, and recommended board layout. These documents are available at www.ti.com <<http://www.ti.com>>.
 - E. Laser cutting apertures with trapezoidal walls and also rounding corners will offer better paste release. Customers should contact their board assembly site for stencil design recommendations. Refer to IPC 7525 for stencil design considerations.
 - F. Customers should contact their board fabrication site for recommended solder mask tolerances and via tenting recommendations for vias placed in the thermal pad.

IMPORTANT NOTICE AND DISCLAIMER

TI PROVIDES TECHNICAL AND RELIABILITY DATA (INCLUDING DATASHEETS), DESIGN RESOURCES (INCLUDING REFERENCE DESIGNS), APPLICATION OR OTHER DESIGN ADVICE, WEB TOOLS, SAFETY INFORMATION, AND OTHER RESOURCES "AS IS" AND WITH ALL FAULTS, AND DISCLAIMS ALL WARRANTIES, EXPRESS AND IMPLIED, INCLUDING WITHOUT LIMITATION ANY IMPLIED WARRANTIES OF MERCHANTABILITY, FITNESS FOR A PARTICULAR PURPOSE OR NON-INFRINGEMENT OF THIRD PARTY INTELLECTUAL PROPERTY RIGHTS.

These resources are intended for skilled developers designing with TI products. You are solely responsible for (1) selecting the appropriate TI products for your application, (2) designing, validating and testing your application, and (3) ensuring your application meets applicable standards, and any other safety, security, or other requirements. These resources are subject to change without notice. TI grants you permission to use these resources only for development of an application that uses the TI products described in the resource. Other reproduction and display of these resources is prohibited. No license is granted to any other TI intellectual property right or to any third party intellectual property right. TI disclaims responsibility for, and you will fully indemnify TI and its representatives against, any claims, damages, costs, losses, and liabilities arising out of your use of these resources.

TI's products are provided subject to TI's Terms of Sale (www.ti.com/legal/termsofsale.html) or other applicable terms available either on ti.com or provided in conjunction with such TI products. TI's provision of these resources does not expand or otherwise alter TI's applicable warranties or warranty disclaimers for TI products.

Mailing Address: Texas Instruments, Post Office Box 655303, Dallas, Texas 75265
Copyright © 2019, Texas Instruments Incorporated